

## Piedino in ferro zincato

Articolo	Finitura	Misura cm
B0152	10	A10
B0153	10	A12
B0154	10	A15

 pz. 100

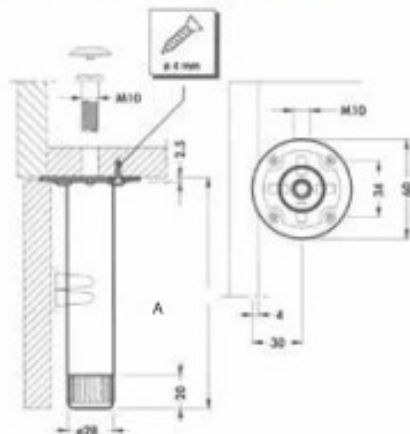

## Piedino in plastica completo di gancio

Articolo	Finitura	Misura cm
B0224N	70	A10
B0403	70	A12
B0225N	70	A15

 cf. 50  
cf = 4 pz.

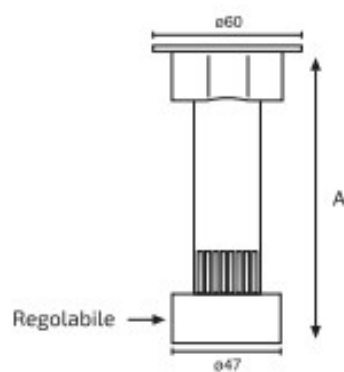

## Piedino rettangolare in zama

Articolo	Finitura	Misura cm
B0195	12	A12
B0196	12	A14

 pz. 12

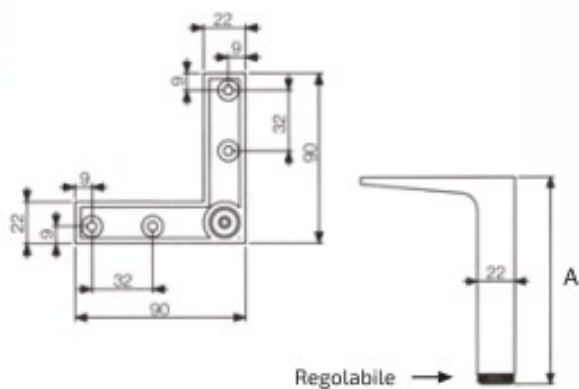

## Piedino ellittico in zama

Articolo	Finitura	Misura cm
B0305	12-52	A10
B0306	12-52	A12
B0307	12-52	A14

 pz. 12

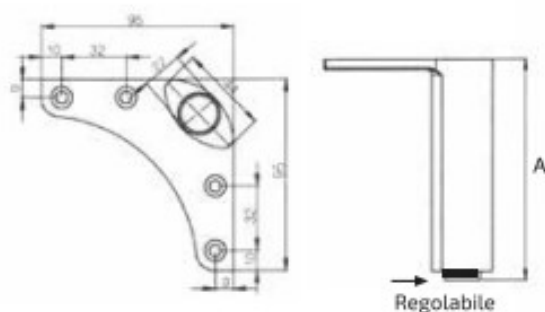

## Piedino tondo in zama

Articolo	Finitura	Misura cm
B0193	12	A12
B0194	12	A14

 pz. 12

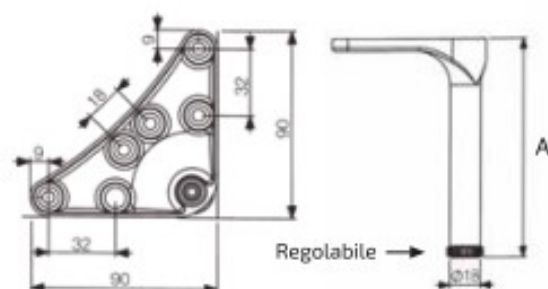

### Piedino conico in ABS

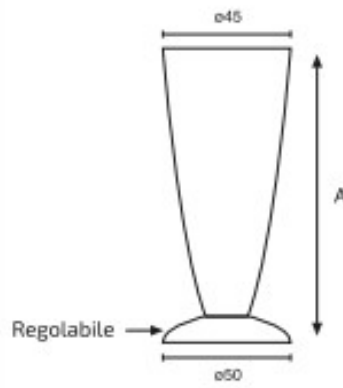

Articolo	Finitura	Misura cm
B0229	12-52	A12

 pz. 40

### Piedino conico in zama

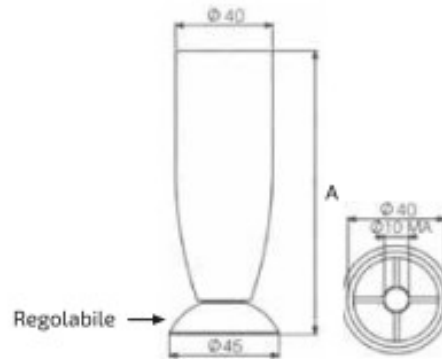

Articolo	Finitura	Misura cm
B0184	12	A10
B0185	12	A12
B0186	12	A14

 pz. 6

### Piedino quadrato in alluminio con piastra

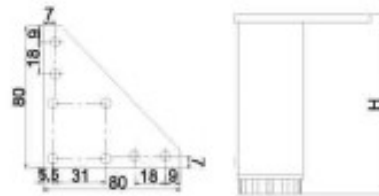

Articolo	Finitura	Misura cm
B0426	12	12

 pz. 40

### Piedino quadrato in alluminio con piastra regolabile in ABS

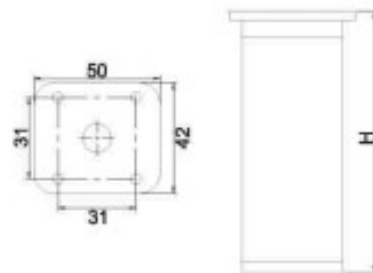

Articolo	Finitura	Misura cm
B0427	12	10

 pz. 40



B0236  
B0237



B0238

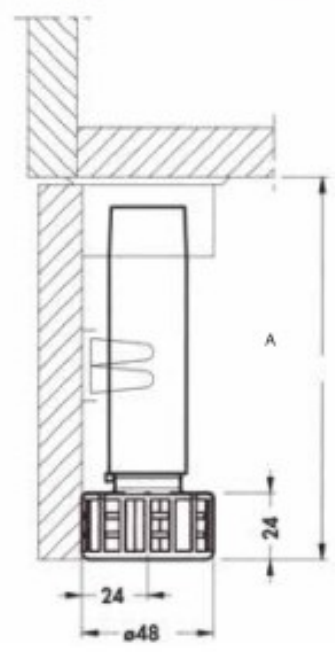

Articolo	Finitura	Misura cm
B0236	10	A10
B0237	10	A12
B0238	10	60-43 mm

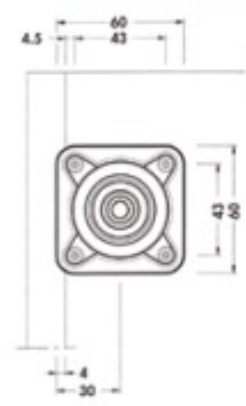

 pz. 40

### Piedino sottosedia

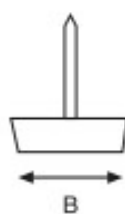

Articolo	Finitura	Misura mm
B0277	60-81	Bø14
B0278	60-81	Bø17
B0279	60-81	Bø20

 pz. 1000

### Piedino sottosedia con feltro

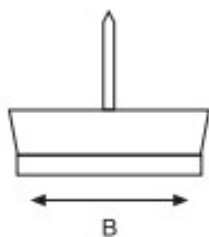

Articolo	Finitura	Misura mm
B0294	60-81	Bø22
B0295	60-81	Bø26
B0296	60-81	Bø30

 pz. 500

### Piedino per mobili

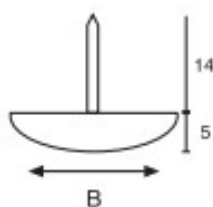

Articolo	Finitura	Misura mm
B0282	92	Bø18

 pz. 1000

### Piattino per mobili

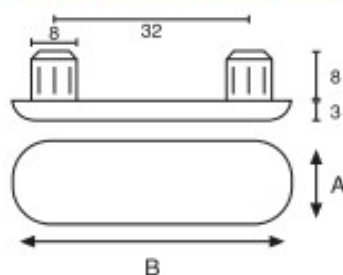

Articolo	Finitura	Misura mm
B0280	60-81	A14-B46

 pz. 1200

## Piedino rettangolare in zama

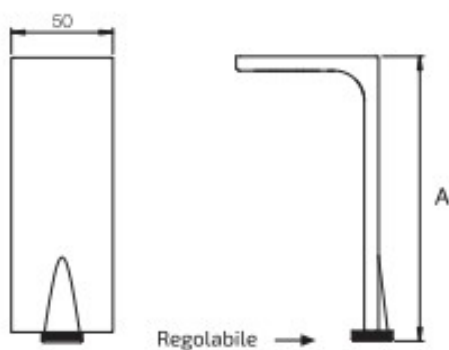

Articolo	Finitura	Misura cm
B0396	12-52	A10
B0397	12-52	A14

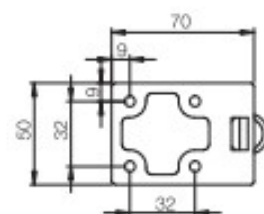

 pz. 12

## Piedino livellatore in zama

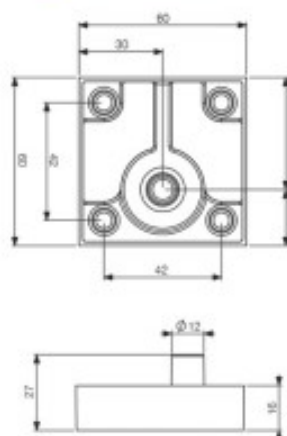

Articolo	Finitura	Misura mm
B0404	12-52	60 x 60

 pz. 12

## Piedino regolabile

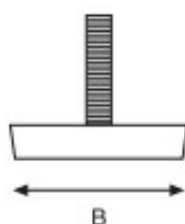

Articolo	Finitura	Misura mm
B0271	70	6MAxBø20
B0272	70	8MAxBø22
B0273	70	10MAxBø25

 pz. 100

## Piede girevole

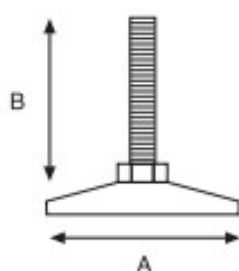

dado 13

dado 13

dado 14

dado 14

dado 14

Articolo	Finitura	Misura mm
B0408	70	8MA-Aø40-B40
B0414	70	8MA-Aø50-B40
B0407	70	10MA-Aø35-B40
B0409	70	10MA-Aø40-B40
B0410	70	10MA-Aø50-B40

 pz. 50

## Piede oscillante

Articolo	Finitura	Misura mm
B0415	70	10 MA-A $\phi$ 60-B40
B0416	70	10 MA-A $\phi$ 80-B70

dado 12

dado 12



pz. 50

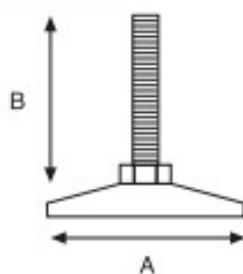

## Base piede regolabile

Articolo	Finitura	Misura mm
B0411	70	A10-B50-C17
B0412	70	A10-B50-C27
B0413	70	A10-B50-C44



pz. 50

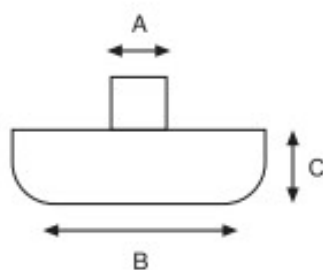

### Piedino conico in plastica

Articolo	Finitura	Misura	Confezione
B0435	12	10 cm	12 pz
B0435	52	10 cm	12 pz



### Piedino conico in zama

Articolo	Finitura	Misura	Confezione
B0484	12	10 cm	12 pz
B0484	52	10 cm	12 pz
B0484	70	10 cm	12 pz
B0485	12	20 cm	4 pz
B0485	52	20 cm	4 pz
B0485	70	20 cm	4 pz

