

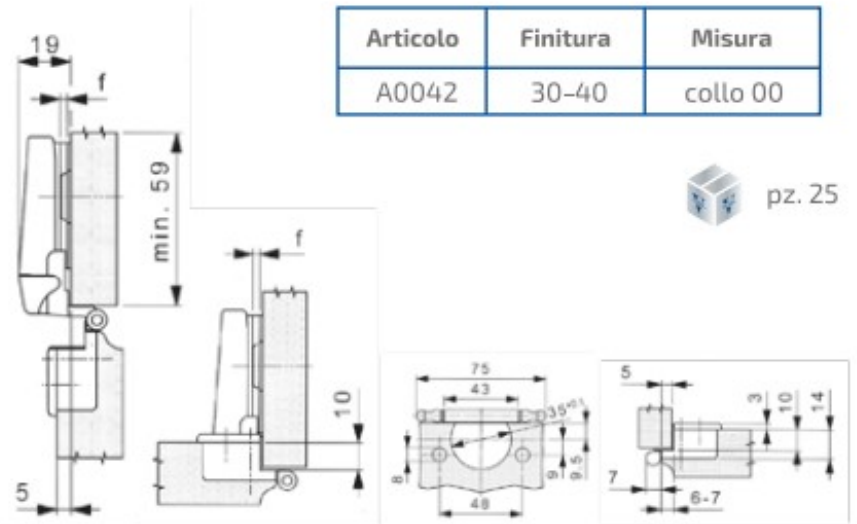

Base A0051



 pz. 25

Articolo	Finitura	Misura
A0043	50	collo 15



Base A0044

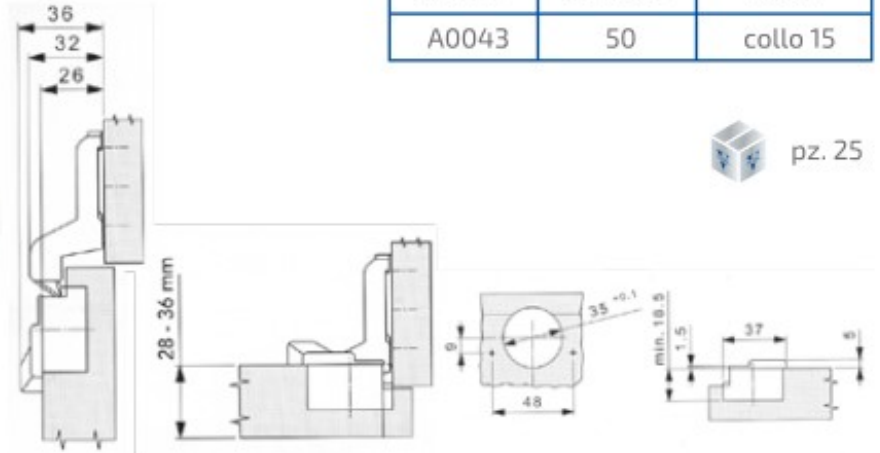

 pz. 25

### Cerniera per porte in luce scodellino ø 32

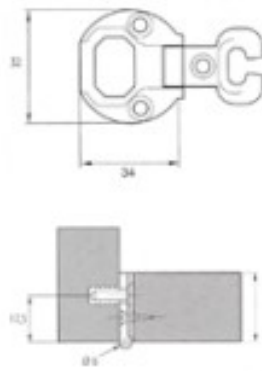

Articolo	Finitura	Misura mm
A0054	30-40	32 x 34

 pz. 50

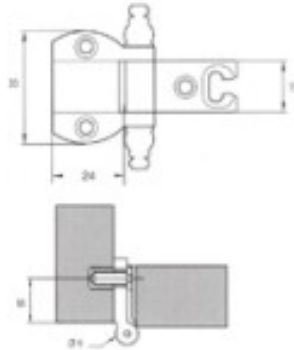

Articolo	Finitura	Misura mm
A0055	30-40	35x24x15

 pz. 50

### Cerniera per porte in luce scodellino ø 35

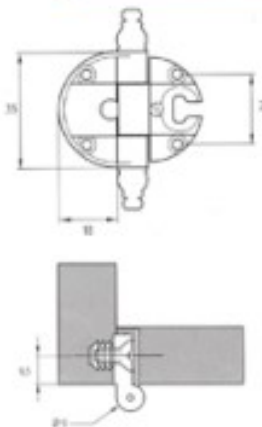

Articolo	Finitura	Misura mm
A0056	30-40	35x18x21

 pz. 50

### Cerniera per porte in luce scodellino ø 35

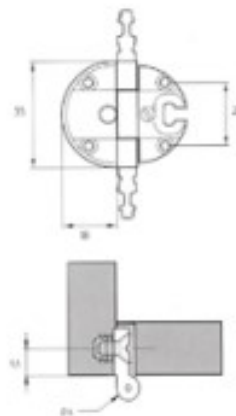

Articolo	Finitura	Misura mm
A0057	30-40	35x18x21

 pz. 50

## Cerniera per porte in luce $\varnothing 35$

Articolo	Finitura	Misura	Confezione
A0057N	30	35x21 mm	100 pz

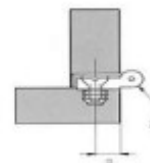

### Cerniera per porte in battuta

Articolo	Finitura	Misura mm
A0058	30-40	46x14x15

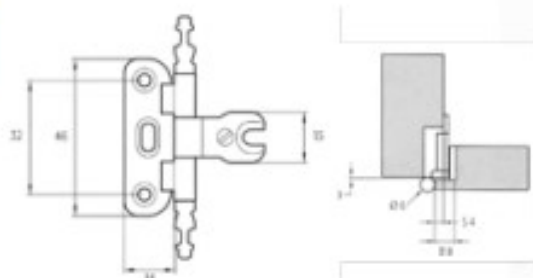

base A0069

### Cerniera per porte in battuta

Articolo	Finitura	Misura mm
A0059	30-40	46x14x14

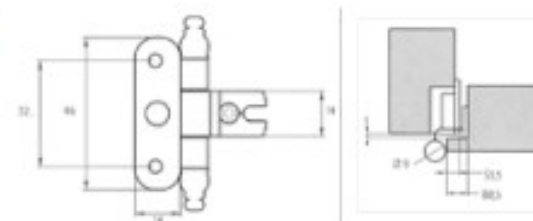

base A0069

### Cerniera per porte in battuta

Articolo	Finitura	Misura mm
A0113	30-40	46x14x14

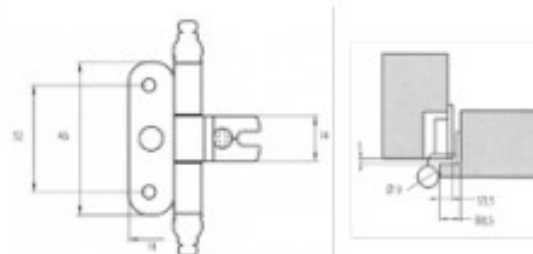

base A0069

### Cerniera per porte in battuta

Articolo	Finitura	Misura mm
A0114	30-40	46x14x14

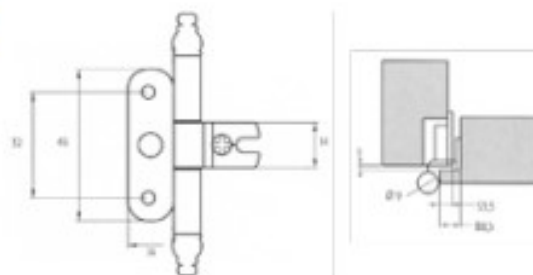

base A0069

## Cerniera per porte in battuta scodellino $\varnothing$ 40

Articolo	Finitura	Misura mm
A0061	30-40	40x15x9,5

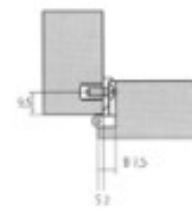
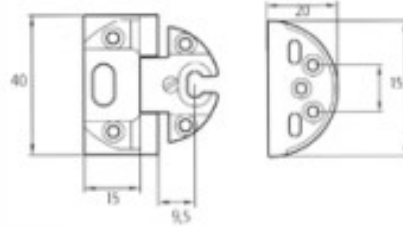

 pz. 50

completa di premontaggio

## Cerniera per porte in luce scodellino $\varnothing$ 35

Articolo	Finitura	Misura mm
A0070	30-40	35 x 25

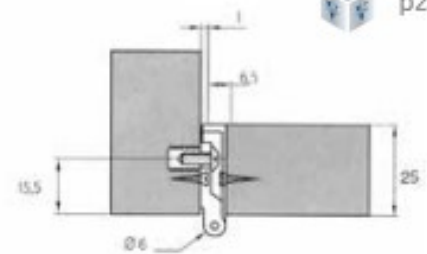
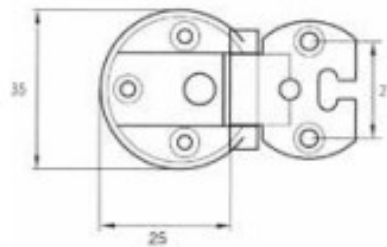

 pz. 50

## Cerniera per porte in battuta scodellino ø 27

Articolo	Finitura	Misura
A0062	30-40	collo 00



 pz. 30

base A0120

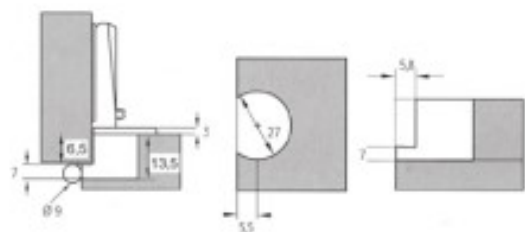

Scodellino parzialmente incassato

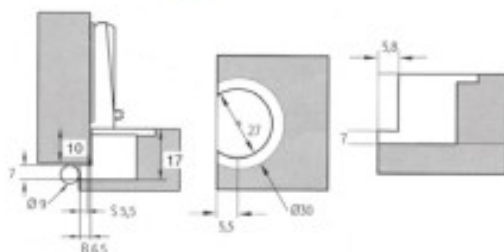
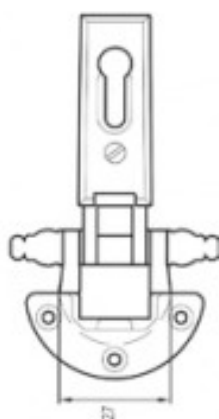

Scodellino totalmente incassato

## Cerniera per porte in battuta scodellino ø 35

Articolo	Finitura	Misura
A0063	30-40	collo 00

 pz. 25

base A0120

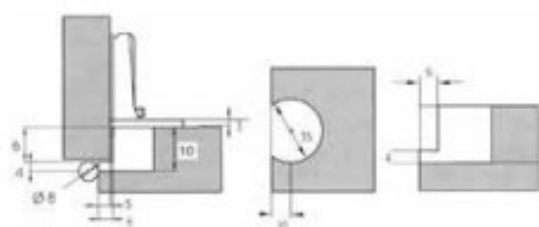

Scodellino parzialmente incassato

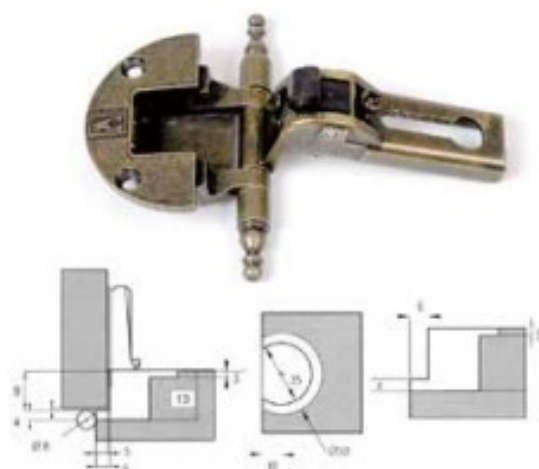
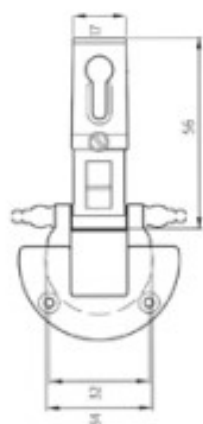

Scodellino totalmente incassato

## Cerniera per ribalta scodellino ø 35

Articolo	Finitura	Misura mm
A0068	50	27x34x16

 pz. 40

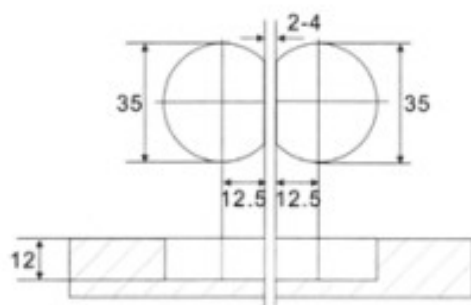

### Cerniera per porte in battuta

Articolo	Finitura	Misura	Confezione
A0064	30	27x16 mm	50 pz

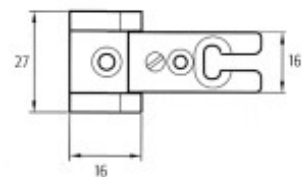

### Cerniera per porte in battuta

Articolo	Finitura	Misura	Confezione
A0109	30	27x34 mm	50 pz

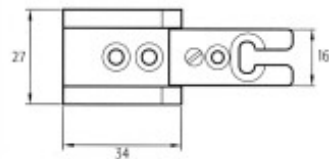



### Cerniera ali plane in ottone

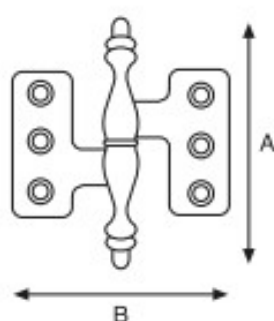

Articolo	Finitura	Misura mm
A0156 (DX)	30-40	A65-B55
A0157 (SX)	30-40	A65-B55

 pz. 24

### Cerniera ali zancate in ottone

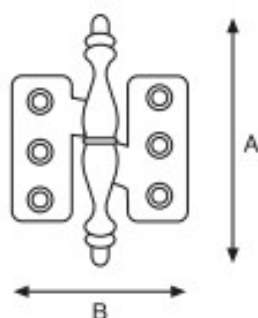

Articolo	Finitura	Misura mm
A0204 (DX)	30-40	A65-B55
A0205 (SX)	30-40	A65-B55

 pz. 24

### Cerniera ali plane in ottone

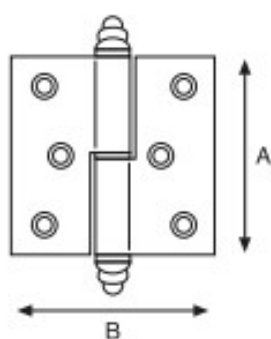

Articolo	Finitura	Misura mm
A0170 (DX)	30-40	A50-B40
A0171 (SX)	30-40	A50-B40

 pz. 20

### Cerniera ali zancate in ottone

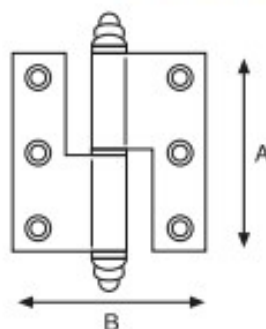

Articolo	Finitura	Misura mm
A0206 (DX)	30-40	A50-B40
A0207 (SX)	30-40	A50-B40

 pz. 24

### Cerniera in ferro verniciato ali plane

Articolo	Finitura	Misura mm
A0158	87	A67-B40

 pz. 50

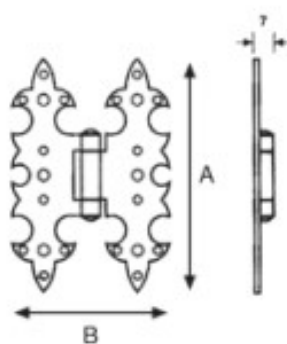

### Cerniera in ferro verniciato ali zancate

Articolo	Finitura	Misura mm
A0159	87	A67-B38

 pz. 40

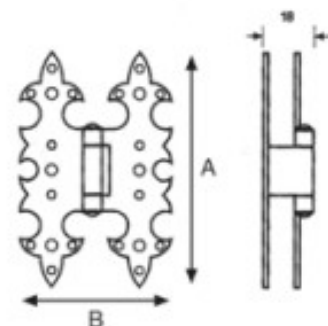

### Cerniera in ferro verniciato ali plane

Articolo	Finitura	Misura mm
A0160	87	A104-B72

 pz. 30

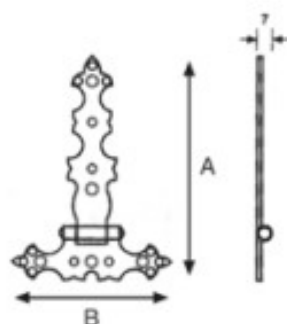

### Cerniera in ferro verniciato ali zancate

Articolo	Finitura	Misura mm
A0161	87	A95-B72

 pz. 30

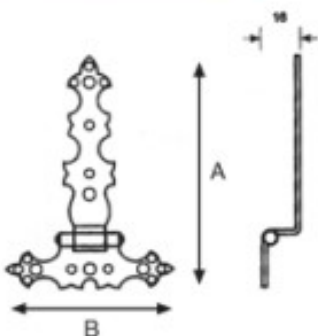

## Cerniera cilindrica in ottone

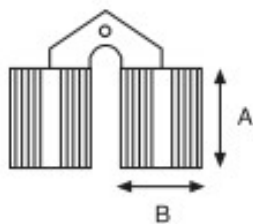

Articolo	Finitura	Misura mm
A0175	40	A11-B10
A0105	40	A13-B12
A0106	40	A15-B14
A0107	40	A17-B16

 pz. 50

## Cerniera per mobili



Articolo	Finitura	Misura mm
A0232	40-51	A40-B10

 pz. 20

## Polisetto in ferro a vite

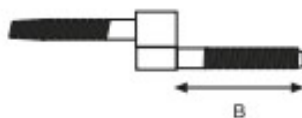

Articolo	Finitura	Misura mm
A0212	70	B36

 pz. 100

## Cerniera invisibile per mobili

Articolo	Finitura	Misura mm
A0200	30-40-51	A45-B13
A0201	30-40-51	A60-B13

 pz. 12

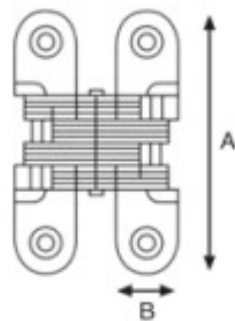
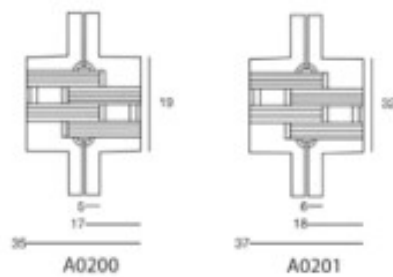

## Cerniera invisibile per mobili

Articolo	Finitura	Misura mm
A0112	30-40-50	A42-B10
A0110	30-40-50	A65-B13

 pz. 20

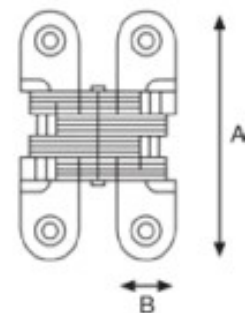

## Cerniera invisibile a soffietto apertura 180° in ottone massiccio

Articolo	Finitura	Misura mm
A0101	40	A41-B46
A0102	40	A52-B46

 pz. 10

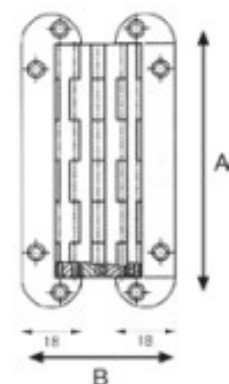

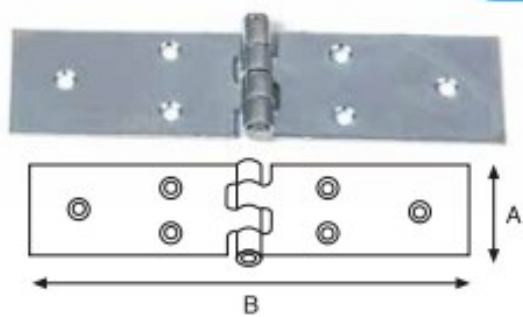

Articolo	Finitura	Misura mm
A0243	10	A22-B51
A0244	10	A25-B80
A0245	10	A25-B99



## Cerniera senza scodellino

Articolo	Finitura	Misura
A0275	50	collo 00

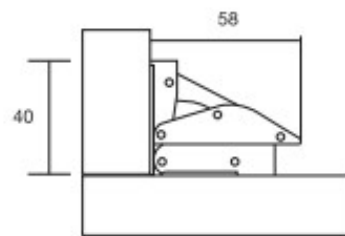

 pz. 20

## Cerniera per ante a ribalta

Articolo	Finitura	Tipologia	Confezione
A0296	50	ANKOR GT-A	25 pz

